



PBU

INFORMACIÓN DEL PRODUCTO

El panel PBU es un sistema de sujetadores expuestos que se puede usar tanto para aplicaciones de techo como de pared. El PBU se puede instalar directamente sobre correas o vigas. El PBU ofrece la versatilidad de ser utilizado tanto en aplicaciones verticales como horizontales para dar a los diseñadores un aspecto contemporáneo para su proyecto de construcción. Se recomienda el PBU para pendientes de techo de 1:12 o más.

- Anchura de Cobertura – 36"
- Espacio entre Nervaduras – 6" entre centros
- Altura de la Nervadura – 3/4"
- Pendiente Mínima – 1:12
- Fijación del Panel – Sistema de Sujeción Expuesta
- Calibre – 26 (estándar); 29, 24, 22 (opcional)
- Acabados – Liso (estándar); En relieve (opcional)
- Recubrimientos – Galvalume Plus®, Signature® 200

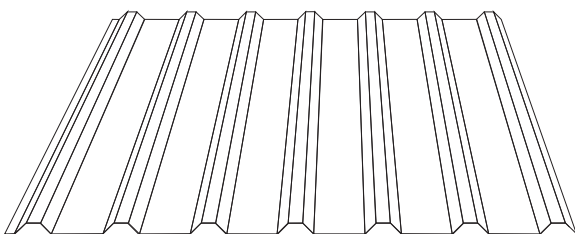

COLORES DE CALIBRE 26



	HAWAIIAN BLUE★		CHARCOAL GRAY★
	CRIMSON RED★		COBALT BLUE★
	FERN GREEN★		RUSTIC RED★
	BURNISHED SLATE★		LIGHT STONE★
	ASH GRAY★		POLAR WHITE★
	SADDLE TAN★		SOLAR WHITE★★★
	DESERT SAND★		GALVALUME PLUS★
	KOKO BROWN★		

★ CALIFICADO ENERGY STAR A TRAVÉS DE NUESTRO SOCIO, MBCI

* También disponible en calibre 29

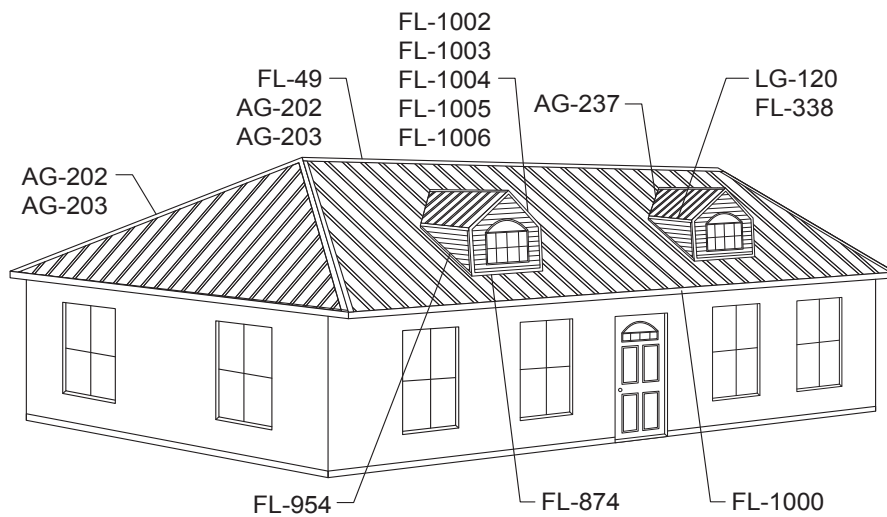
** Se pueden requerir cantidades mínimas y/o plazos de entrega extendidos

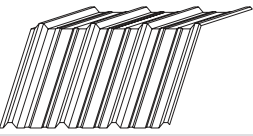
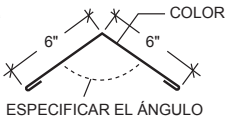

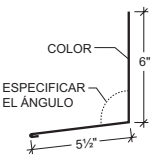
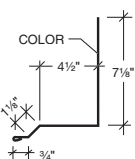
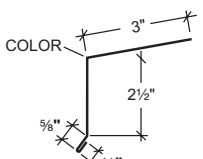
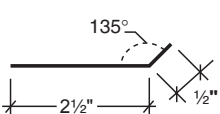
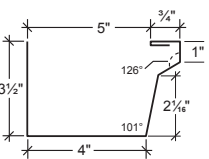
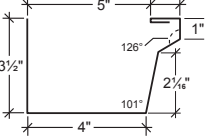
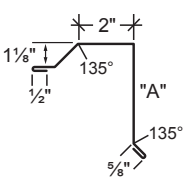
ARTÍCULO	Nº DE PIEZA	PENDIENTE	DIM "A"	LONGITUD	CIRCUNFERENCIA	CALIBRE
Cumbrera Estampada 	FL-50	1:12 - 5:12	N/A	2'-6"	N/A	26 GA
NOTA: Especificar la pendiente del techo • La pendiente máxima del techo es de 5:12						
Tapajuntas de Cumbrera/Lima 	AG-202 AG-203		N/A	10'-2" 20'-2"	13" 13"	26 GA 26 GA
NOTA: Especificar la pendiente del techo y si se usa para la cumbrera o lima						
Limahoya Estándar 	AG-237 AG-238		N/A N/A	10'-2" 10'-2"	20 3/8" 20 3/8"	26 GA 26 GA
NOTA: Especificar la pendiente del techo						
Moldura de Alero Alto de Parapeto 	FL-874 FL-875		N/A N/A	10'-2" 20'-2"	12" 12"	26 GA 26 GA
NOTA: Especificar la pendiente del techo						
Inclinación de Pretil 	FL-954 FL-855		N/A N/A	10' - 2" 20' - 2"	14" 14"	26 GA 26 GA
Moldura de Alero 	LG-120		N/A	10'-6"	6 5/8"	29 GA
NOTA: Especificar la pendiente del techo - Especificar el ribete abierto si se usa la abrazadera continua						
Abrazadera Continua 	FL-338		N/A	10'-2"	3"	24 GA
Canalón 	FL-1000		N/A	10'-2"	12 9/16"	24, 26 y 29 GA
Cabecera de Canalón (derecha o izquierda) 	FL-1001		N/A	N/A	N/A	24, 26 y 29 GA
Inclinación 	FL-1002 FL-1003 FL-1004 FL-1005 FL-1006	3-4 : 12 5-6 : 12 7 : 12 8-9 : 12 10 : 12	3 3/16" 3 1/16" 2 15/16" 2 13/16" 2 11/16"	10'-2" 10'-2" 10'-2" 10'-2" 10'-2"	8 1/16" 8 9/16" 8 7/16" 8 5/16" 8 3/16"	26 y 29 GA 26 y 29 GA 26 y 29 GA 26 y 29 GA 26 y 29 GA
NOTA: Especificar el ribete abierto si se usa la abrazadera continua						

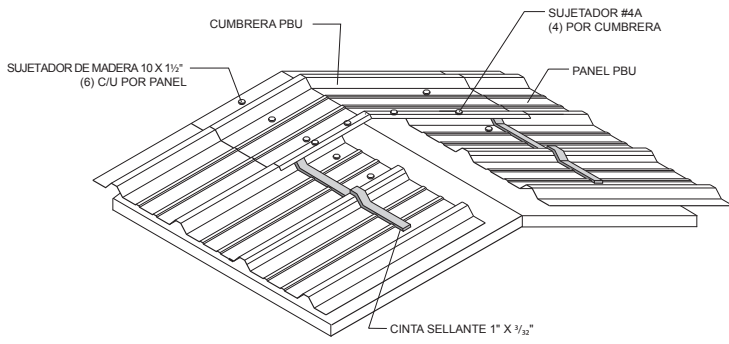

CUMBRERA

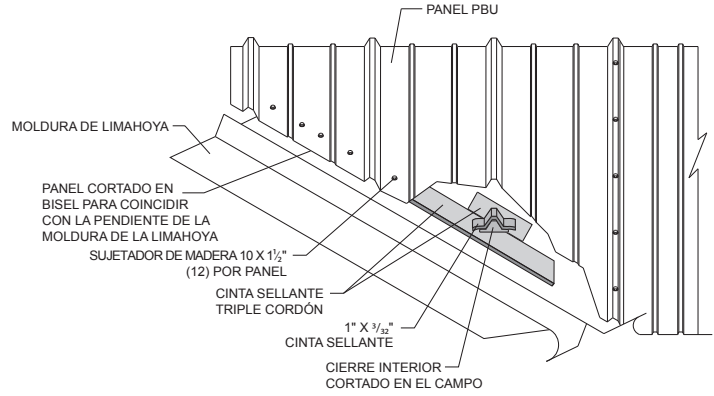

LIMAHOYA

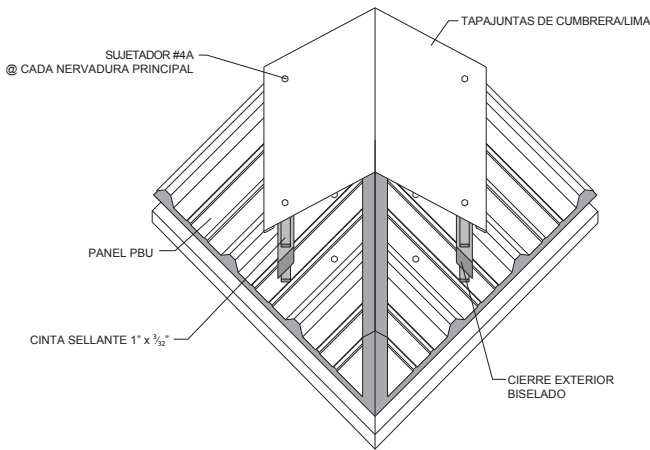

LIMA

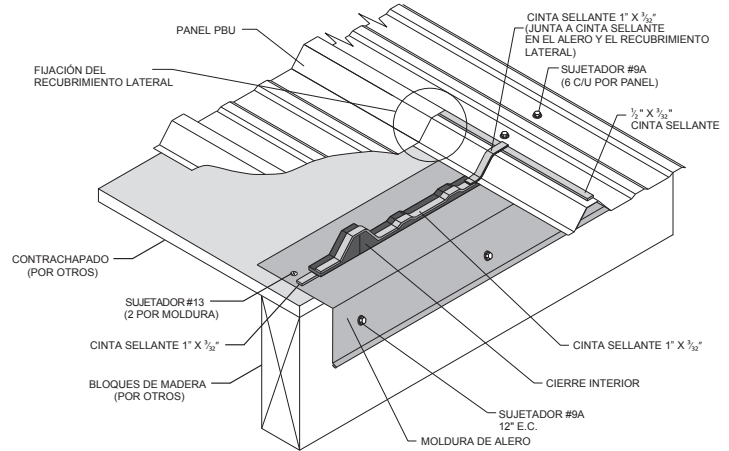

MOLDURA DE ALERO

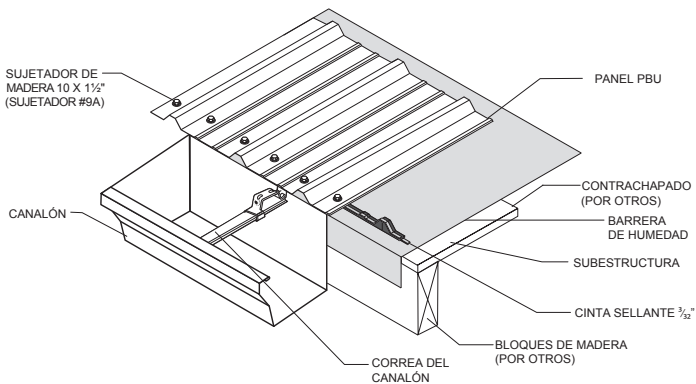

CANALÓN

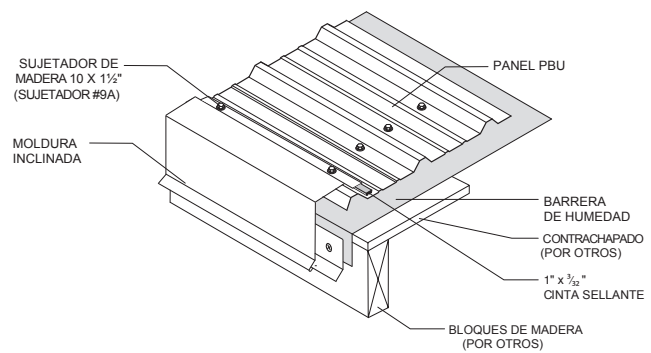

INCLINACIÓN

Pintura para Retoques



Nº PIEZA	TIPO	TAMAÑO
HW-304	Signature® 200	2 oz.
HW-305	Signature® 300	2 oz.

Vasos Magnéticos

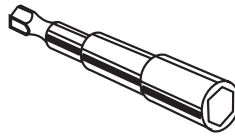

Nº PIEZA	TAMAÑO
HW-604	Accionamiento Hex 3/8"
HW-605	Accionamiento Hex 5/16"
HW-606	Accionamiento Hex 1/4"

Soporte de Canalón

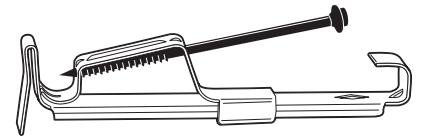

Nº PIEZA
HW-339

Tiras de Cierre de Panel "PBU"

NOTA: Se requiere una por panel

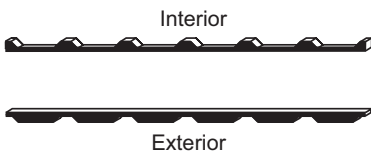

Nº PIEZA	TIPO	ADHESIVO
HW-459	Interior	No
HW-460	Exterior	Sí

Soporte de Techo de Caucho

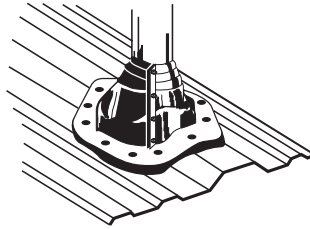

Nº PIEZA	GAMA TEMP.	TAM. TUB.	DIM. BASE	PESO C/U
HW-1000	-65°F a +212°F	1/4" - 2"	4 1/2"	0,17#
HW-1001	-65°F a +212°F	1/4" - 5"	8"	0,50#
HW-1002	-65°F a +212°F	4" - 7"	11"	0,95#
HW-1003	-65°F a +212°F	6" - 11"	14"	1,55#
HW-1004	-65°F a +212°F	7" - 13"	17"	2,56#
ALTA TEMPERATURA				
HW-1046	-100°F a +437°F	1/4" - 5"	8"	0,50#
HW-1047	-100°F a +437°F	4" - 7"	11"	0,95#
HW-1048	-100°F a +437°F	7" - 13"	17"	2,56#
HW-1049	-100°F a +437°F	10" - 18"	25"	3,86#

Autoperforante Lap-Tek

250 por Bolsa

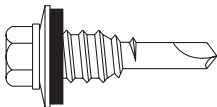

Nº PIEZA	TAMAÑO DE CABEZA	LONGITUD
4A	5/16"	14 x 7/8"

Sujetador de Madera de Larga Duración

Panel a Madera Maciza



*Otros tamaños disponibles. Por favor pregunte.

Nº PIEZA	TAMAÑO DE CABEZA	LONGITUD
9A	5/16"	10 x 1"
9	5/16"	10 x 1 1/2"

Remache Pop

250 por Bolsa | Acero Inoxidable



Nº PIEZA	DIÁMETRO	RANGO DE AGARRE
14	1/8"	1/8" x 3/16"

Sujetador de Madera

Panel a Madera Maciza

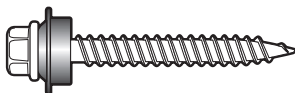

*Otros tamaños disponibles. Por favor pregunte.

Nº PIEZA	TAMAÑO DE CABEZA	LONGITUD
8A	1/4"	10 x 1"
8	1/4"	10 x 1 1/2"
8B	1/4"	10 x 2"
8C	1/4"	10 x 2 1/2"

Cinta Sellante

Plana

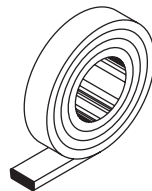

Nº PIEZA	GENERAL	LONGITUD
HW-502	2 1/2" x 3/16"	20'-0"
HW-507	1/2" x 3/32"	50'-0"
HW-508	1" x 3/32"	40'-0"

Tubo de Sellante

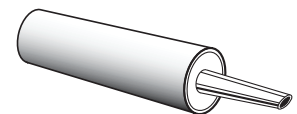

Nº PIEZA	TIPO	COLOR
HW-548	Acrílico	Blanco
HW-550	Acrílico	Gris
HW-540	Uretano	Blanco
HW-541	Uretano	Gris
HW-542	Uretano	Bronce
HW-544	Uretano	Almendra

NOTA: 25' por tubo para un cordón de 1/4"