



# INFORMACIÓN DEL PRODUCTO

El panel de techo 5V Crimp ofrece una apariencia residencial antigua ideal. El panel 5V Crimp también es una solución estéticamente agradable para aplicaciones comerciales ligeras. Los paneles 5V Crimp requieren un techo sólido con una membrana impermeable.

- Anchura de Cobertura – 24”
- Espacio entre Nervaduras – 12” entre centros
- Altura de la Nervadura – 1/2”
- Pendiente Mínima – 3:12
- Fijación del Panel – Sistema de Sujeción Expuesta
- Calibre – 29 (Galvalume Plus® sólo); 26 (Opcional)
- Acabados – Liso (estándar)
- Recubrimientos – Galvalume Plus®, Signature® 200

## COLORES DE CALIBRE 26



GALVALUME PLUS® ★

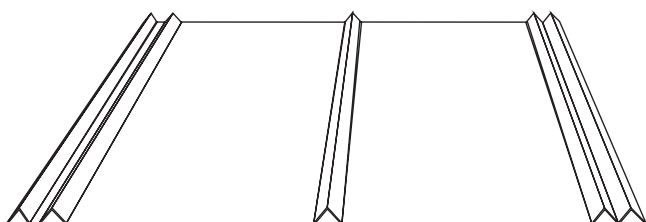

\* Sólo Galvalume Plus® disponible en calibre 29

★ CALIFICADO ENERGY STAR A TRAVÉS DE NUESTRO SOCIO, MBCI

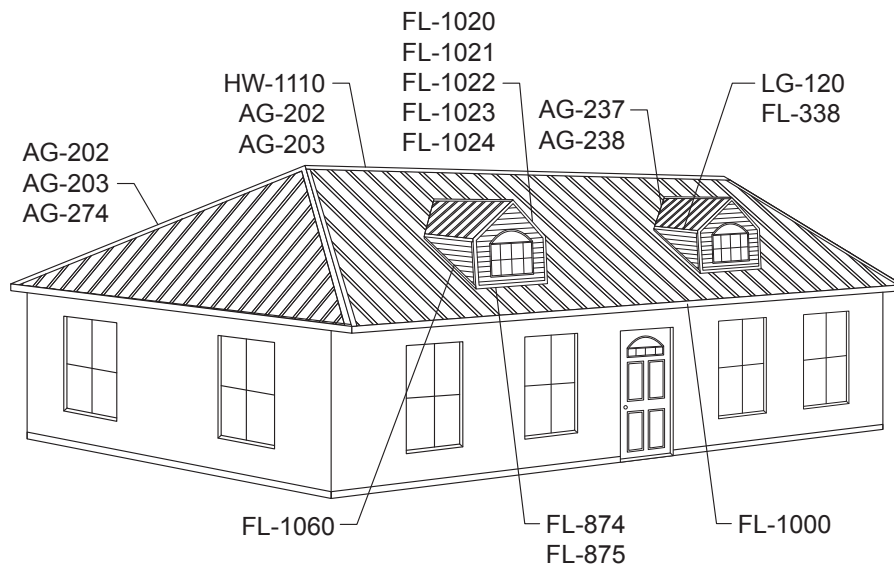

5V CRIMP

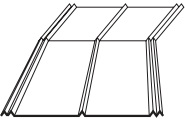

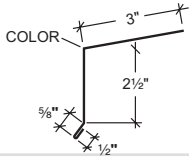
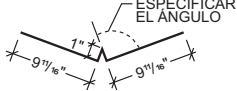
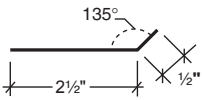
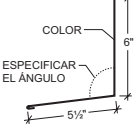
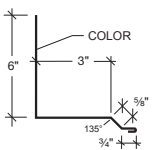
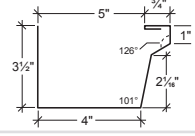
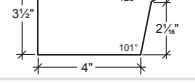
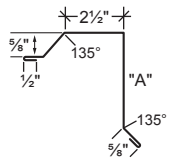
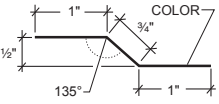
ARTÍCULO	Nº DE PIEZA	PENDIENTE	DIM "A"	LONGITUD	CIRCUNFERENCIA	CALIBRE
<b>Cumbrera Estampada</b> 	HW-1110	¼:12 - 9:12	N/A	1'-2"	N/A	29 GA
	HW-1110	¼:12 - 9:12	N/A	1'-2"	N/A	26 GA
<b>NOTA:</b> Especificar la pendiente del techo						
<b>Tapajuntas de Cumbrera/Lima</b> 	AG-202		N/A	10' - 6"	13"	29 GA
	AG-202		N/A	10' - 2"	13"	26 GA
	AG-203		N/A	20' - 2"	13"	29 GA
	AG-203		N/A	20' - 2"	13"	26 GA
<b>NOTA:</b> Especificar la pendiente del techo o el ángulo indicado en el plano						
<b>Moldura de Alero</b> 	LG-120			10' - 6"	6 5/8"	29 GA
<b>NOTA:</b> Especificar la pendiente del techo - Especificar el ribete abierto si se usa la abrazadera continua						
<b>Limahoya Estándar</b> 	AG-237		N/A	10' - 2"	21 3/8"	26 GA
	AG-238		N/A	20' - 2"	21 3/8"	26 GA
<b>NOTA:</b> Especificar la pendiente del techo o el ángulo indicado en el plano						
<b>Abrazadera Continua</b> 	FL-338		N/A	10' - 2"	3"	24 GA
<b>Moldura de Alero Alto de Parapeto</b> 	FL-874			10' - 2"	12"	26 GA
	FL-875			20' - 2"	12"	26 GA
<b>NOTA:</b> Especificar la pendiente del techo o el ángulo indicado en el plano						
<b>Inclinación de Pretil</b> 	FL-1060		N/A	10' - 2"	10 7/8"	26 y 29 GA
<b>Canalón</b> 	FL-1000		N/A	10' - 2"	12 9/16"	24, 26 y 29 GA
<b>Cabecera de Canalón</b> (derecha o izquierda) 	FL-1001		N/A	N/A	N/A	24, 26 y 29 GA
<b>Inclinación</b> 	FL-1020	3-4:12	2 15/16"	10' - 2"	8 7/16"	26 y 29 GA
	FL-1021	5-6:12	2 13/16"	10' - 2"	8 5/16"	26 y 29 GA
	FL-1022	7:12	2 11/16"	10' - 2"	8 3/16"	26 y 29 GA
	FL-1023	8-9:12	2 9/16"	10' - 2"	8 1/16"	26 y 29 GA
	FL-1024	10:12	2 7/16"	10' - 2"	7 15/16"	26 y 29 GA
<b>Cierre en 'Z'</b> 	AG-274		N/A	10' - 2"	2 3/4"	26 GA

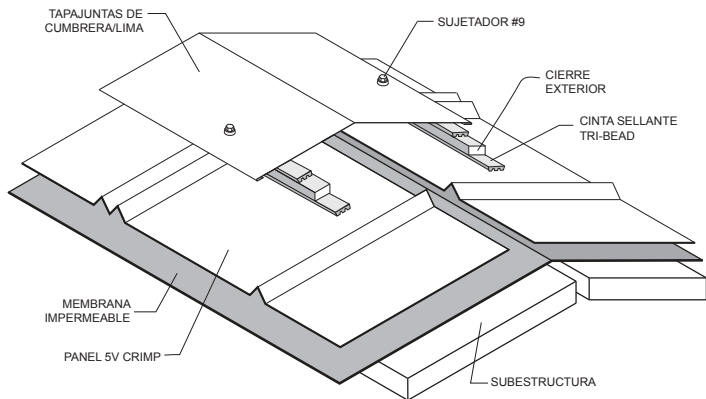

## CUMBREIRA

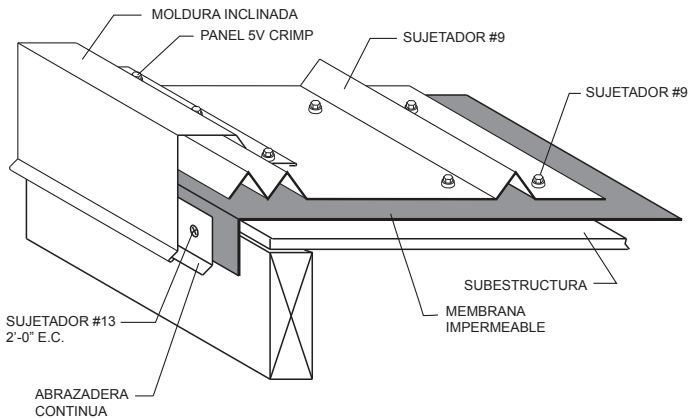

## INCLINACIÓN

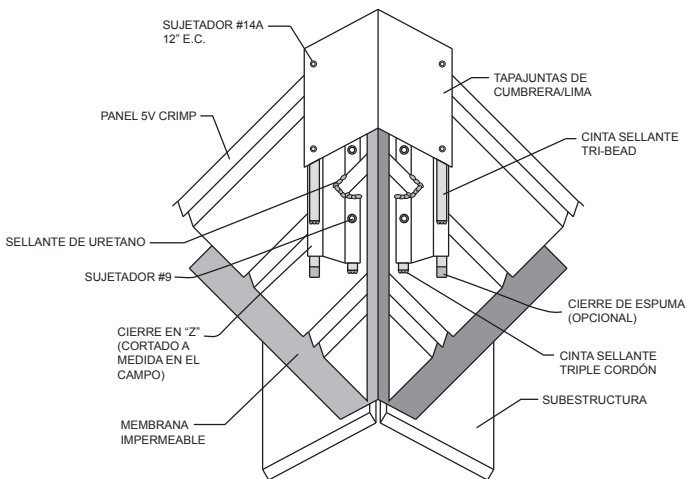

## LIMA

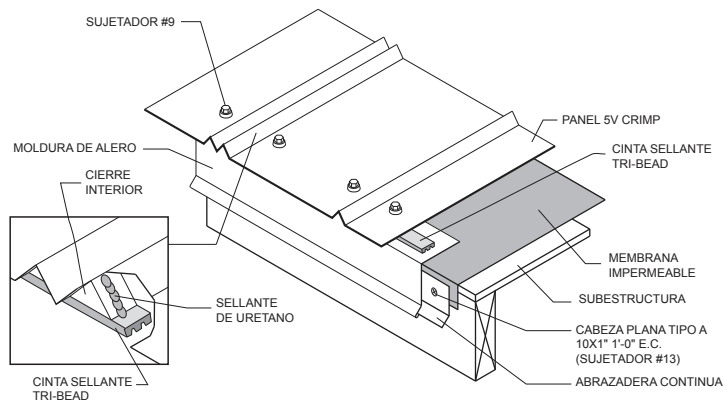

## MOLDURA DE ALERO

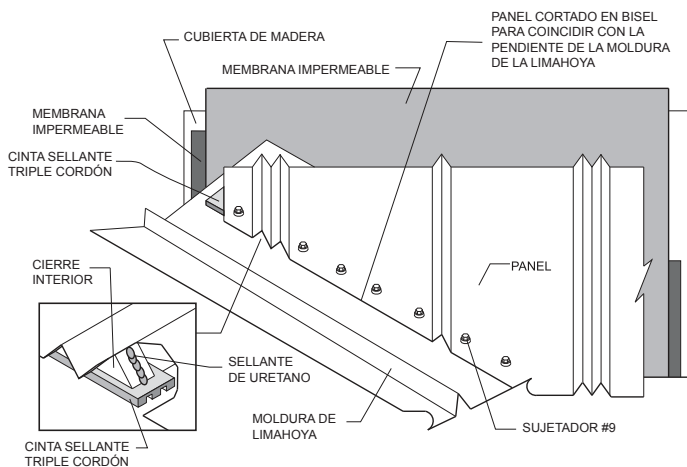

## LIMAHOYA

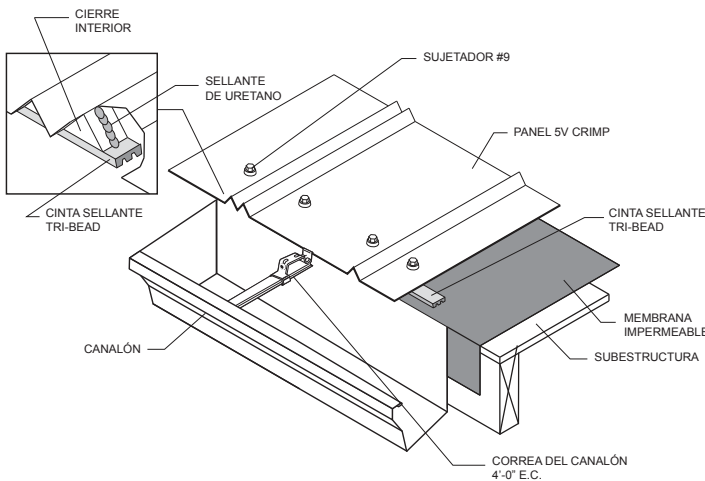

## CANALÓN

## Pintura para Retoques



Nº PIEZA	TIPO	TAMAÑO
HW-304	Signature® 200	2 oz.
HW-305	Signature® 300	2 oz.

## Vasos Magnéticos

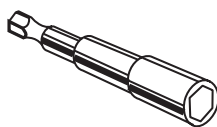

Nº PIEZA	TAMAÑO
HW-604	Accionamiento Hex 3/8"
HW-605	Accionamiento Hex 5/16"
HW-606	Accionamiento Hex 1/4"

## Soporte de Canalón

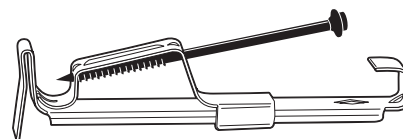

Nº PIEZA
HW-339

## Tiras de Cierre de Panel 5V Crimp

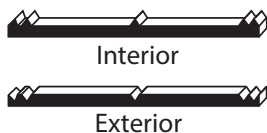

Nº PIEZA	TIPO	ADHESIVO	TAMAÑO
HW-450	Interior	No	1" x 24"
HW-452	Exterior	Sí	1" x 24"

## Soporte de Techo de Caucho

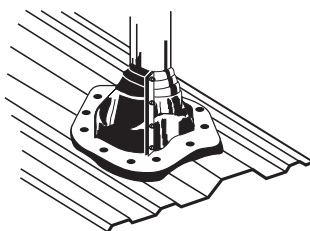

Nº PIEZA	GAMA TEMP.	TAM. TUB.	DIM. BASE	PESO C/U
HW-1000	-65°F a +212°F	1/4" - 2"	4 1/2"	0,17#
HW-1001	-65°F a +212°F	1/4" - 5"	8"	0,50#
HW-1002	-65°F a +212°F	4" - 7"	11"	0,95#
HW-1003	-65°F a +212°F	6" - 11"	14"	1,55#
HW-1004	-65°F a +212°F	7" - 13"	17"	2,56#
ALTA TEMPERATURA				
HW-1046	-100°F a +437°F	1/4" - 5"	8"	0,50#
HW-1047	-100°F a +437°F	4" - 7"	11"	0,95#
HW-1048	-100°F a +437°F	7" - 13"	17"	2,56#
HW-1049	-100°F a +437°F	10" - 18"	25"	3,86#

## Sujetador Recubierto de Larga Duración Silver Sentri® Woodgrip

Panel a Madera Maciza

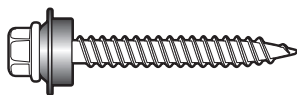

\*Otros tamaños disponibles. Por favor pregunte.

Nº PIEZA	LONGITUD
8A	10 x 1"
8	10 x 1 1/2"
8B	10 x 2"
8C	10 x 2 1/2"

## Sujetador de Larga Duración Zac® Woodgrip

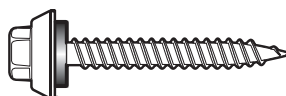

\*Otros tamaños disponibles. Por favor pregunte.

Nº PIEZA	LONGITUD
9A	10 x 1"
9	10 x 1 1/2"

## Remache Pop

250 por Bolsa | Acero Inoxidable



Nº PIEZA	TAMAÑO DE CABEZA	LONGITUD
14	5/16"	1/8" x 3/16"

## Tubo de Sellante

NOTA: 25' por tubo para un cordón de 1/4"

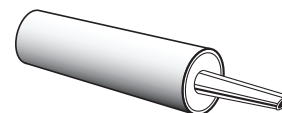

Nº PIEZA	TIPO	COLOR
HW-548	Acrílico	Blanco
HW-550	Acrílico	Gris
HW-540	Uretano	Blanco
HW-541	Uretano	Gris
HW-542	Uretano	Bronce
HW-544	Uretano	Almendra

## Autoperforante Lap-Tek

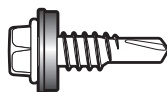

Nº PIEZA	TAMAÑO DE CABEZA	LONGITUD
4A	5/16"	14 x 7/8"

## Cinta Sellante

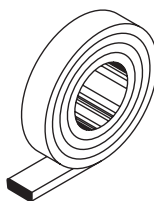

Nº PIEZA	GENERAL	LONGITUD
HW-502	2 1/2" x 3/16"	20'-0"
HW-504	7/8" x 3/16"	25'-0"



Llámenos o visítenos en línea o en la tienda más cercana para hablar con un experto en proyectos y obtener más información sobre nuestras ofertas de productos.

www.metaldepots.com

© Metal Depots 2019, parte de la familia Cornerstone Building Brands. Todos los derechos reservados.

MANTÉNGASE EN CONTACTO  
facebook.com/metaldepots

